

Varenummer: 3901210015700  
 Beskrivelse: Snekkegear med fri indgangsaksel  
 VF 210P-15-HS

## Mål

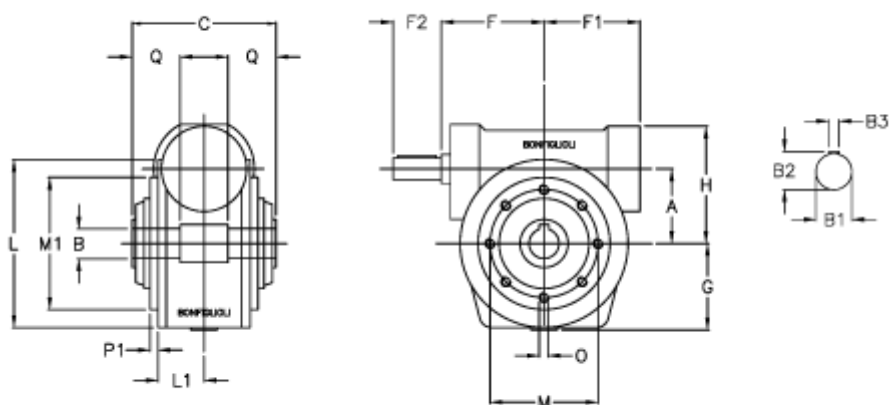

a	= 210.0	F1	= 277	O	= M16x30
B	= 90	F2	= 110	P1	= 5.0
B1	= 48	g	= 220	Q	= 85.0
B2	= 51.5	H	= 330		
B3	= 14	L	= 350.0		
Betegnelse	= VF 210P-xx-HS	L1	= 125.0		
C	= 260	m	= 300		
F	= 230.0	M1	= 250		